

PYLE

OWNER'S MANUAL

PLTVD-137



FOLD DOWN DETACHABLE PANEL

CAR DVD/ VCD/ WMA/ CD/ MP3 PLAYER/ RECEIVER WITH TV TUNER

www.pyleaudio.com

Contents

Thank you for buying this product.

Please read through these operation instruments so you will know how to operate your model properly. After reading please keep this booklet in safe place for future reference.

1 Before You Start

- Important Safeguards* 4
- About this manual* 4
- Precautions* 5
- Maintenance* 5
- Location & function of the controls* 7
- Remote control* 8
- Specifications* 8

2 Installation

- Wiring Connections* 11
- Installation* 12
- Detach the Unit* 13

3 Common Operations

- Reset the Unit* 14
- Turning the Unit On/Off* 14
- Volume Control* 14
- SHIFT Function* 14
- Mode Selector* 14
- Infrared Sensor* 14
- Eject a Disc* 14

4 DVD

- Basic Operation of DVD* 15
- Playing Tracks F.F./REW* 15
- Number Buttons* 15
- Repeat Playing* 15
- Stop the Playback* 15
- Pause the Playback* 15
- Playing the Previous/Next Track* 15
- System Button* 15
- Slow Motion Playback* 15
- Increase Picture Size* 15
- On Screen Display* 15
- Changing the Angle of View* 15
- Changing Audio Language* 17
- Changing the Subtitle Language* 17
- Selecting Different Menu/Title* 17
- Set Up Menu* 17-18

Contents

5 VCD/CD/MP3

- Basic Operation of Discs* 2A
- Playing Tracks F.F.F.REW* 2A
- Number Buttons* 2A
- Repeat Playing* 2A
- Stop the Playback* 2A
- Pause the Playback* 2A
- Playing the Previous/Next Track* 2A
- System Button* 2B
- Slow Motion Playback* 2B
- Increase Picture Size* 2B
- On Screen Display* 2B
- MO/ST Selector* 2B
- MP3 Selector* 2B
- Paying PBC (Menu)* 2B

6 TV

- Turn the Unit On/Off* 2B
- MO/ST Selector* 2B
- TV Mode* 2B
- Mute Function* 2B
- System Selector* 2B
- Stations Selector* 2B

7 Additional Information

- Simple Troubleshooting Guide* 27

Before You Start

IMPORTANT SAFEGUARDS

1. **Be sure to connect the color coded leads according to the diagram. Incorrect connections may cause the unit to malfunction or damage the vehicle's electrical system.**
2. **Be sure to connect the speaker (-) leads to the speaker (-) terminal. Never connect the left and right channel speaker cables each other or to the vehicle body.**
3. **Make sure all the connections are completely correct before turning on your unit.**
4. **When replacing the fuse(s), the replacement must be of the same amperage as shown on the fuse holder.**
5. **Do not block vents or radiator panels. Blocking them will cause heat to build up inside and may result in fire.**
6. **After completing the installation and beginning to play the unit (including replacing the battery), please remove the front panel at first, and then press RESET button on the base with pointed object (such as ball-point pen) to set the unit to initial status.**





About this manual

This unit features a number of sophisticated functions ensuring superior operation. All the functions have been designed for the easiest possible use, but many are not self-explanatory. This manual will help you understand the functions and operations of the unit. This manual main explains **remote control operation**. However, in addition to those functions related with DVD/VCD/CD/MP3/TV operation that can only be operated by the remote control, there are also functions can be operated by the buttons provided for the main unit.

Before You Start

PRECAUTIONS

This unit can play the following discs only:

Type of disc	Label on the disc	Recorded material	Size of disc
DVD		Sound and moving pictures	12cm
VCD		Sound and moving pictures	12cm
CD		Sound only	12cm
MP3		Sound only	12cm

NOTE: The unit is compatible with VCD1.0/2.0/3.0 version and DVCD disc.

- **Do not attempt to modify the unit, modifying the unit may cause an accident.**
- **Stop the vehicle before carrying out any operation that could interfere with your driving.**
- **Do not work in extremely high or low temperature. Be sure the temperature inside the vehicle is between +60° C and -10 °C before turning on your unit.**
- **To enjoy optimum sound and images while playing, handle the discs as follows:**

—Handle the disc by its edge to keep the disc clean, and do not touch the surface.



—Do not use your CDs with paste residue or ink attached.



—Do not use CDs with labels or stickers attached, which may leave a sticky residue while beginning to peel off.
(Shown as the picture)



—Clean the discs with an optional cleaning cloth. Wipe each disc from the center out.
(Shown as the picture)



Before You Start

Maintenance

Replacing the Fuse

Make sure the amperage matches the specified value when replacing the fuses. If the fuse is blown, check the power connection and replace with a new one. If the same problem occurs, it would be subjected to the malfunction. In such cases, please consult to the nearest service dealer.

Warning

Never use the fuse with the rated amperage more than that supplied to your unit, otherwise it will damage the unit.

Replacing the Battery

When the range of the operation of the card remote control becomes short or no functions while operating. Replace the lithium battery with a new button cell (CR2025). Make sure the battery polarity before replace.

Gently pull out the Battery Holder while pressing the Stopper.



Put the button-type battery with mark(+) upward into the Battery Holder.



Insert the Battery Holder into the Remote Control.



Precautions on Using Lithium Battery

Always keep the lithium battery beyond children's reach. In case swallowed, see a doctor immediately.

Cleaning the battery with a dry cloth, to ensure its perfect connected.

Make sure the proper polarity when loading with the battery.

To prevent short circuit, do not use metal tweezers to clip the battery.

Warning!

Improper handle with the battery may lead to explosion. It cannot be charged, disassembled or thrown into a fire.

Before You Start

Location of the Controls

Front Panel

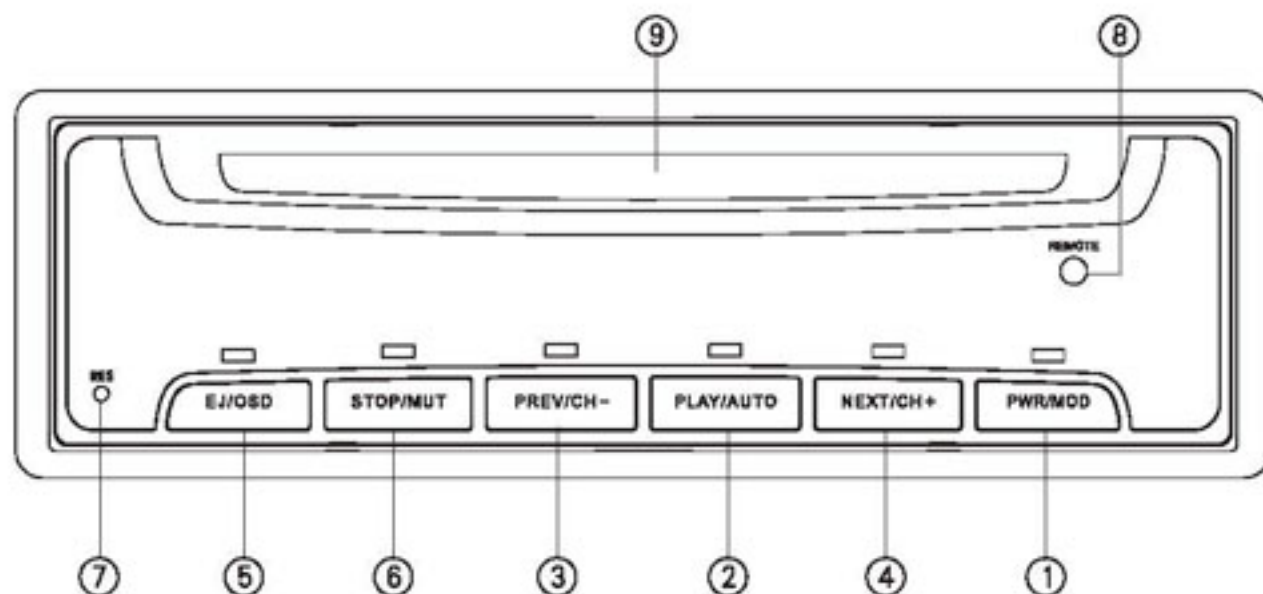

- ① **POWER/MOD**
Press to turn on the unit, and keep press to turn off it. After turning on the unit, shortly press this button to switch the TV mode and playback mode.
- ② **PLAY/AUTO**
Press to switch sequentially between playback and pause; during the stop mode, you can also press to resume to playback; during TV mode, press to scan the stations automatically.
- ③ **PREV/CH-**
Press to play the previous track. During TV mode, press to select the optional channels.
- ④ **NEXT/CH+**
Press to play the next track. During TV mode, press to select the optional channels.
- ⑤ **EJECT/OSD**
Press it to eject the disc. During TV mode, press to shows the current mode.
- ⑥ **STOP/MUTE**
Press to stop the playback. During TV mode, press to cut down the sound output.
- ⑦ **RESET**
Press to set the unit to initial status.
- ⑧ **REMOTE**
Remote control receptor.
- ⑨ **DISC LOADING SLOT**

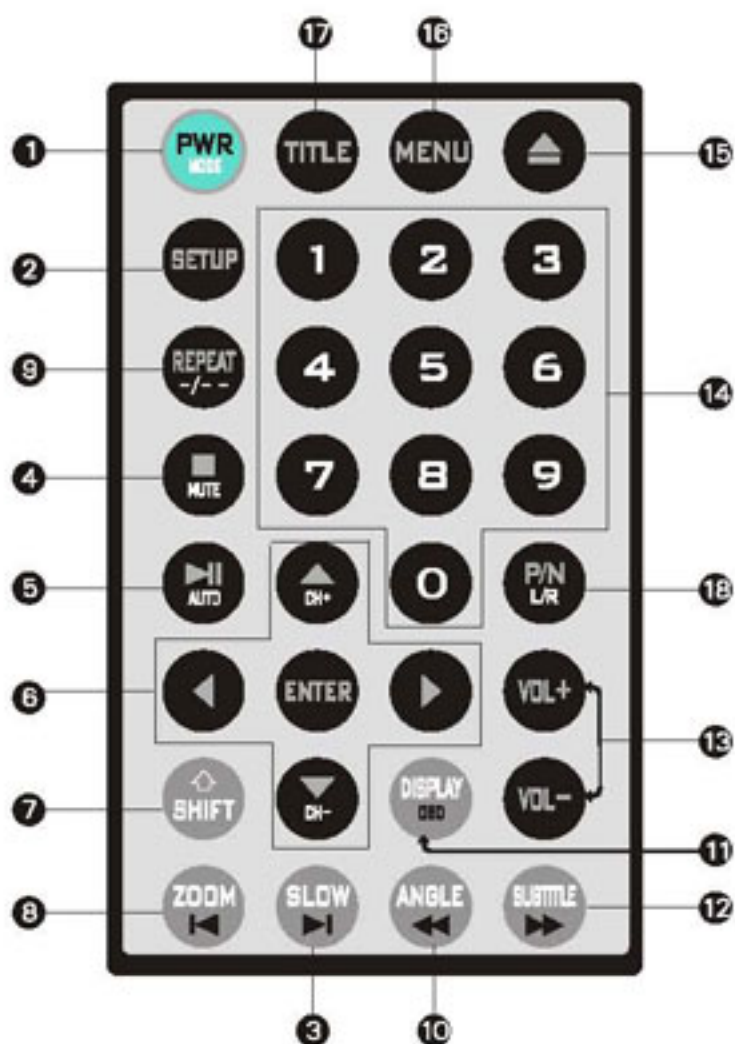
Card Remote Control**Tips:**

For more information as to replacing battery, please refer to **Replacing the Battery** on page 6.

Before You Start

- 1 POWER/MODE**
Press to turn on the unit, and keep press to turn off it. After turning on the unit, shortly press this button to switch the TV mode and playback mode.
- 2 SETUP**
During playback, press this button to display the main menu, you can select the desired options.
- 3 SLOW/▶**
Press to slow forward during playback. Press ▶ to play the next track.
- 4 ■ STOP/MUTE**
During playback, press this button to stop playing;
During TV mode, press it to mute.
- 5 ▶|| PLAY/PAUSE/AUTO**
During playback, press to switch sequentially between playback and pause; during stop mode, press to resume to playback.
During TV mode, press to scan stations automatically.
- 6 [◀][▶][▲][▼][ENTER]/[CH-][CH+]**
In the main menu, press [◀][▶][▲][▼] to move cursor upward, downward, leftward or rightward, and then press [ENTER] to execute the entering or the selected item. During TV mode, press [CH-][CH+] to select channels up and down.
- 7 SHIFT**
When shift function is activated, press the buttons which have double functions, the upper function is valid.
- 8 ZOOM/I◀**
Press ZOOM to change the size of the picture;
First press I◀ to replay the current track. Press it again within 3 seconds, to play the previous track.
- 9 [REPEAT]/[-/--]**
During playback, press this button to activate the REPEAT function;
During TV mode, press it to start 10+ function.
- 10 ANGLE/◀◀**
During DVD mode, press this button to change the view angle;
During playback, press it to faster reverse.
- 11 DISPLAY/OSD**
During playback, press this button to show the relative menu;
During TV mode, press it to show the current status.
- 12 SUBTITLE/▶▶**
During DVD mode, press this button to change the subtitle language;
During playback, press it to perform faster forward.
- 13 VOL+/VOL-**
Press to increase or decrease volume level.
- 14 NUMBER BUTTONS**
Press to select track, or chapter.
- 15 ▲**
Press to eject the disc.
- 16 MENU**
During DVD mode, press it to return the root menu.
- 17 TITLE**
During DVD mode, press to return to the main page of the title menu;
During VCD mode, press to active PBC (Playback Control) function.
- 18 [P/N]/[L/R]**
Press this button to select the video system or left, right or stereo channel.

Specifications

General

Power Requirement	14.4V DC (11-16V allowable)
Load Impedance	10K Ω
Max.Level Output	2V/CH
Dimensions	Approx.168x178x50 mm (d/w/h)
Mounting Dimensions	Approx.150x182x53 mm (d/w/h)
Weight	Approx.1.1kg

VCD/CD Player Section

VCD Signal System	PAL/NTSC
Signal-to-noise Ratio	75dB
Separation	70dB(1KHz)
Distortion	0.1%

DVD Player Section

Number of channel	2 channels
Frequency Response	20Hz—20,000Hz
Dynamic Range	98dB
Signal-to-Noise Ratio	90(JIS)
Wow and Flutter	Less than measurable limit

Note:

Due to continuous product improvement, specifications and design are subject to change without prior notice.

Installation

Wiring Connection

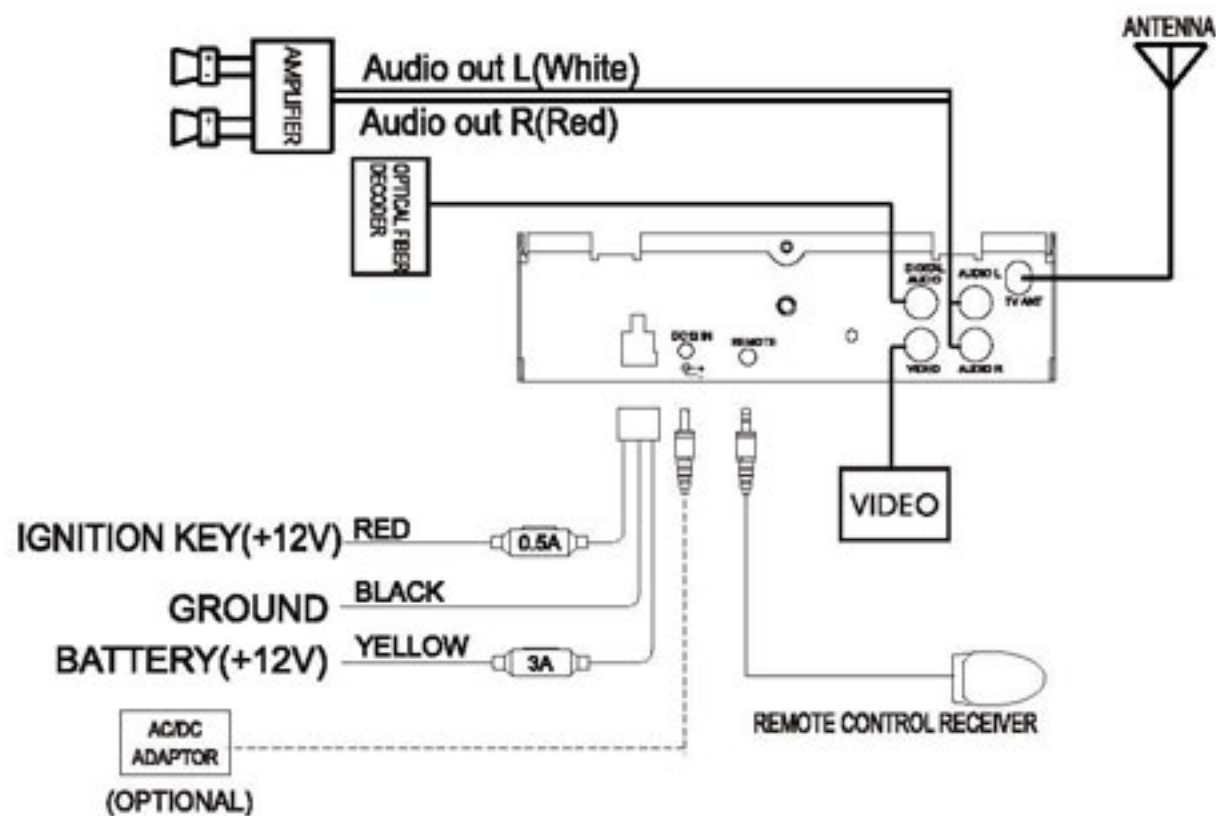

Install the Unit

Installation Method1

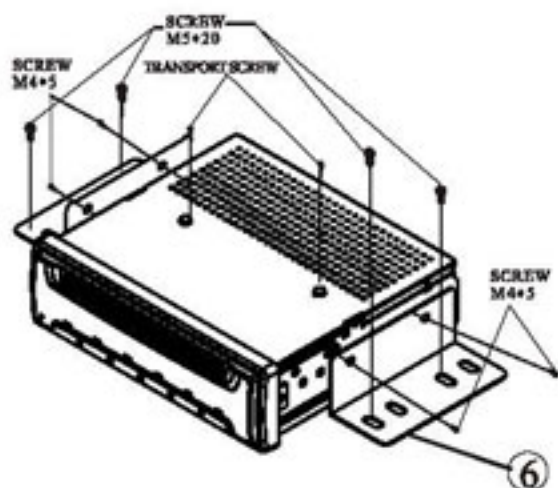

Installation Method2

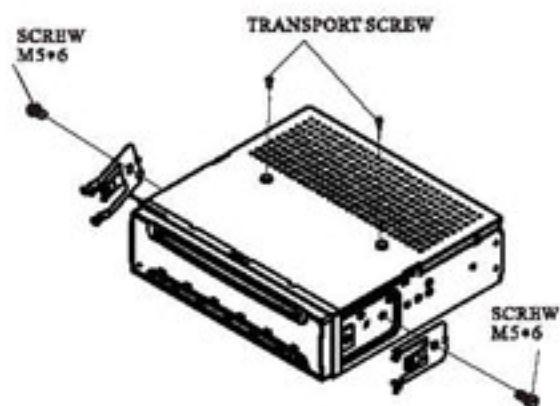

Installation Method2

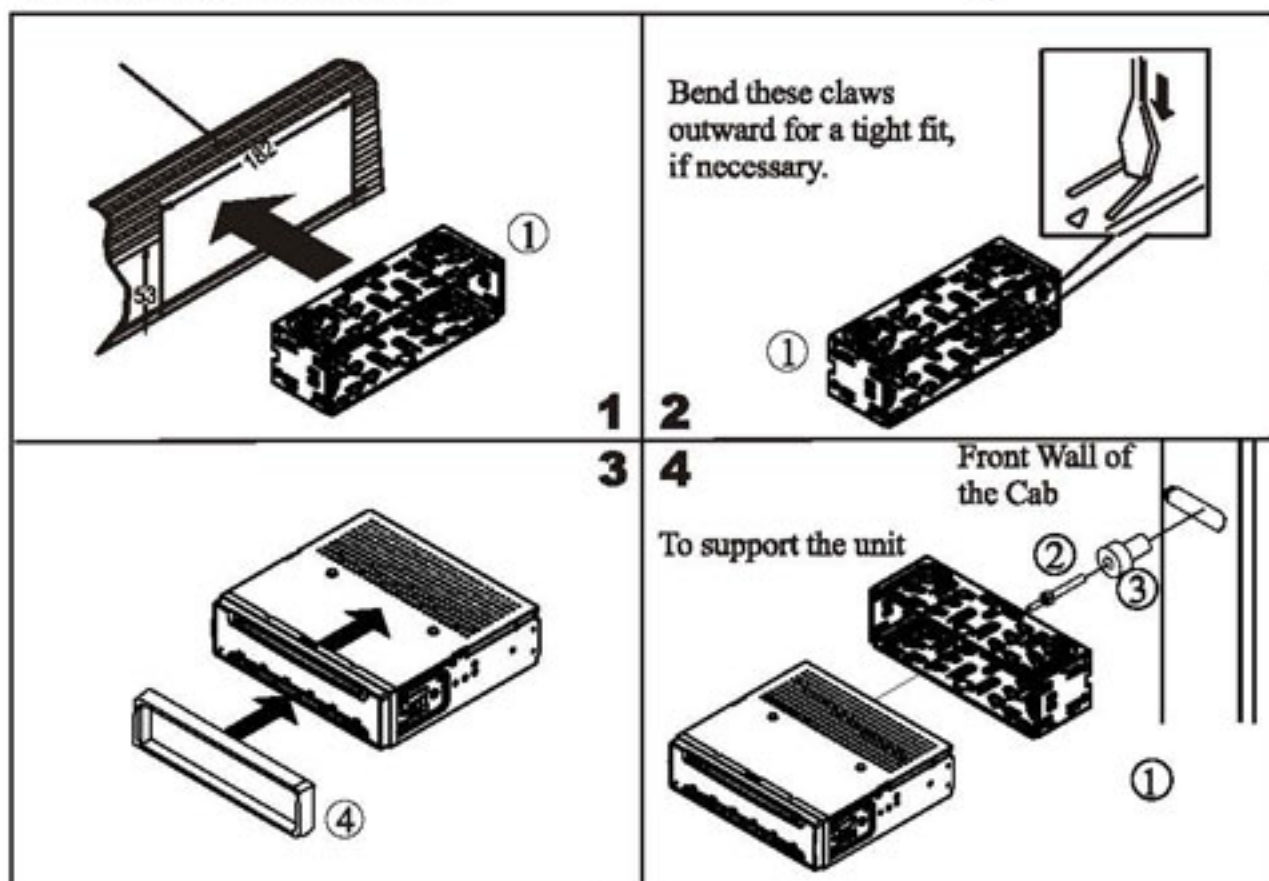

Installation

Detach the Unit (for Installation Method2)

1. Remove the outer trim frame.

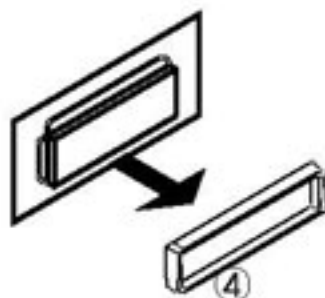

2. Insert the keys supplied with the unit at both sides of the unit as shown in figure until they click. Pulling the keys makes it possible to remove the unit from the dashboard.

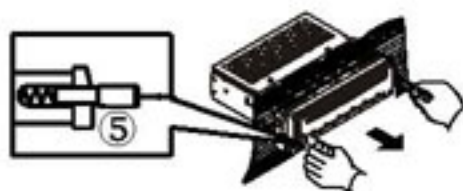

- ① Mounting Sleeve x1 ② Rear Mounting Bolt x1 ③ Harness Rubber x1 or Metallic Lath x 1
 ④ Outer Trim Frame x1 ⑤ Key x2 ⑥ Bracket

Common Operations

Reset the Unit

Before operating the unit for the first time or after replacing the car battery, the unit must be reset.

Remove the front panel at first, and then Press **7** **RESET** button on the base with a pointed object, (such as a ballpoint pen) to set the unit to initial status.

Note:

- * When some errors occur on the display, you can also press **RESET** button to resume to normal, and it will erase the clock setting and some memorized functions.
- * This function can only be operated by the head unit.

Turning the Unit On/Off

Press **1** **PWR** button to turn on the unit, press it again, the unit is still in the waiting status. When insert a disc, the unit will automatically start playing. Keep pressing it to turn off the unit completely.

Note:

- * When the unit is on, insert a disc, it will be played automatically.
- * Pressing **POWER** button in the head unit also performs the same operation.

Volume Control

Press **13** **VOL+** button to increase the sound level and press **13** **VOL-** button to decrease the sound level.

Note:

- * This function can only be operated by the remote control.

Shift Function

Press **7** **SHIFT** button, **fS** appears in the monitor, the upper function is valid. Press it again, **fS** disappears, and the nether one is valid.

Note:

- * This function can only be operated by the remote control.

Mode Selector

Press **1** **MODE** button to select TV mode or playback mode.

Note:

- * Briefly pressing **MODE** in the head unit also performs the same operation.

Infrared Sensor:

Receptor **8** on the head unit for the card remote commander.

Eject a Disc

Press **13** **▲** to eject a disc.

Note:

- * Pressing **EJ** in the head unit also performs the same operation.

DVD

Basic operation of DVD

Insert a DVD disc into the slot, the unit will automatically switch on, if a DVD disc is loaded, press **1** **MODE** in the remote control to start the playback.

Note:

- * Pressing MOD button in the head unit also performs the same operation.
- * The disc can be inserted and ejected in AV mode.

Playing Track F.F/F.REW

Press **12** **FF** or **10** **F.RW** to play the track fast forward or fast rewind: each pressing, the change is as following:

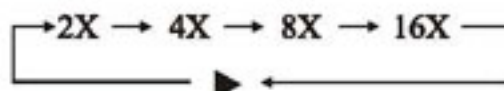

Note:

- * This function can only be operated by the remote control.

Number Buttons

press **13** **Number Buttons** to input the desired tracks, then it will be played automatically.

Note:

- * This function is operated by using the remote control.

Repeat Playing

press **9** **REPEAT** to replay as following:

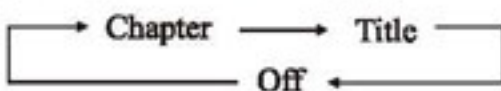

Note:

- * This function is operated by using the remote control.
- * The default setting is **DISC REPEAT**.

Stop the playback

During DVD mode, firstly pressing **4** **■** to pause playing, pres **5** **▶** to play, press **■** button twice to stop playing completely, press **PLAY** button to start playing.

Note:

- * Pressing STOP in the head unit also performs the same function.

Pause the playback

During DVD mode, press **5** **▶** to switch pause and play mode, during stop mode, press it again to resume to the playback mode.

Note:

- * Pressing PLAY in the head unit also performs the same function.

Playing the Previous/Next Track

During DVD playback, briefly press **8** **◀** to replay the current track, briefly press it again within 3 seconds to play the previous track, briefly press **6** **▶** to play the next one.

Note:

- * Pressing PREV and NEXT button in the head unit also perform the same operation.

System Button

During DVD playback, press **7** **SHIFT** till **fS** appears, then press **13** **P/N** button to select standard TV system as following:

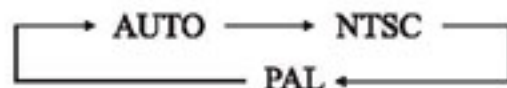

Note:

- This function also can be operated by the DVD SETUP MENU

Slow motion playback

During DVD playback, press **7** **SHIFT** till **fS** appears, press **6** **SLOW** to slow forward or slow backward. There are such speeds each pressing decreases the speed until the minimum speed is reached as follows:

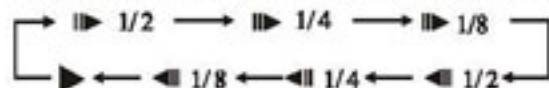

Note:

- This function is operated by using the remote control.

Increase the size of the picture

During DVD playback, press **7** **SHIFT** till **fS** appears, press **3** **ZOOM** to increase the picture in size. There are such sizes as following:

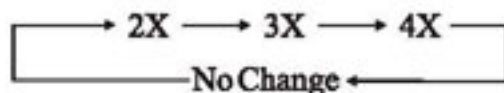

Note:

- This function is operated by using the remote control.
- Pressing **[<] [] [▲] [▼]** to remove the picture.

On-screen display

During DVD playback, press **11** **DISPLAY**, the monitor shows:

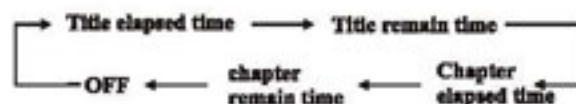

Note:

- This function is operated by using the remote control.



Changing the viewing angle (Multi-angle)

With DVDs featuring multi-angle (scenes shot from multiple angles) recordings, you can firstly press **7** **SHIFT** till **fS** appears, then press **10** **ANGLE** to switch among viewing angles during playback.

Selection options switch as follows:

ANGLE 1 — **ANGLE 2** — **ANGLE 3**

Note:

- This function is operated by using the remote control.
- This  mark on a DVD package indicates it features multi-angles scenes, The number in the  mark indicates the number of angles from which scenes were shot.

DVD

Changing audio language (Multi-audio)

DVDs can provide audio playback with different languages. With DVDs featuring multi-audio recordings, it can be switch between language and audio systems during playback.

During playback, repeatedly pressing **L/R** the selection options switch as follows:

AUDIO 1 — AUDIO 2 — AUDIO 3

Note:

- This function is operated by using the remote control.
- This function is only operated by DVDs with multi-audio recordings.
- The number in the “**ⓐ**” mark on a DVD's package indicates the number of recorded languages/audio systems.

Changing the subtitle language (Multi-subtitle)

With DVDs featuring multi-subtitle recordings. You can switch the subtitle languages during playback.

During playback, press **SHIFT** till **FS** appears, then repeatedly **SUBTITLE**, the selection options switch as follows:

Subtitles 1 — Subtitles 2 — Subtitles OFF

Note:

- This function is operated by using the remote control.
- The function is only operated by DVDs with multi-subtitle recordings.
- The number in the “**ⓐ**” mark on a DVD's package indicates the number of recorded subtitle languages.

Selecting Different Menu/Title

Under DVD playback mode, press **MENU** or **TITLE** to return to the root menu or the title menu, the monitor display all the chapters or all titles. You can press **6** and **Number Buttons** on the remote control to select different chapter or title.

Note:

- This function is operated by using the remote control.

SET UP MENU

During DVD playback, press **SET UP**, the screen will display system setting picture, the user can select some relative constant parameters. The user also can set it as needed by moving the cursor and using **6** [**▲**][**▼**][**◀**][**▶**] buttons, and then press **ENTER** to execute the selecting or entering item.

Note:

- If the disc that is inserted does not have the preferred option then the disc's own preference will be used.
- Regarding SETUP MENU, please refer to pages 22-27 for more details.
- Some functions varies depending on the types of models or formats of the disc.

--General Setup Page--**TV Display**

Example showing how to set TV Display mode:

(Press ▲ or ▼)

--General Setup Page--

TV Display	Wide
Angle Mark	On
OSD Lang	Eng
SPDIF Output	
Captions	Off
Screen Saver	On

Go To General Setup Page



(Press ►, ▲ or ▼, then press ENTER)

--General Setup Page--

TV Display	Wide	Normal/PS
Angle Mark	On	Normal/LB
OSD Lang	Eng	Wide
SPDIF Output		
Captions	Off	
Screen Saver	On	

Set TV Display mode

Angle Mark

Example showing how to set picture mode:

(Press ▲ or ▼)

--General Setup Page--

TV Display	Wide
Angle Mark	On
OSD Lang	Eng
SPDIF Output	
Captions	Off
Screen Saver	On

Go To General Setup Page



(Press ►, ▲ or ▼, then press ENTER)

--General Setup Page--

TV Display	Wide	
Angle Mark	On	On
OSD Lang	Eng	Off
SPDIF Output		
Captions	Off	
Screen Saver	On	

Set Angle Mark

OSD Lang

Example showing how to set language mode:

(Press ▲ or ▼)

--General Setup Page--

TV Display	Wide
Angle Mark	On
OSD Lang	Eng
SPDIF Output	
Captions	Off
Screen Saver	On

Go To General Setup Page



(Press ►, ▲ or ▼, then press ENTER)

--General Setup Page--

TV Display	Wide	
Angle Mark	On	
OSD Lang	Eng	English
SPDIF Output		
Captions	Off	
Screen Saver	On	

Set OSD Language

--General Setup Page--**SPDIF Output**

Example showing how to set language mode:

(Press ▲ or ▼)

--General Setup Page--

TV Display	Wide
Angle Mark	On
OSD Lang	Eng
SPDIF Output	
Captions	Off
Screen Saver	On

Go To General Setup Page



(Press ►, ▲ or ▼, then press ENTER)

--General Setup Page--

TV Display	Wide
Angle Mark	On
OSD Lang	Eng
SPDIF Output	SPDIF OFF
Captions	Off
Screen Saver	On

Set SPDIF Output

Captions

Example showing how to set captions on/off:

(Press ▲ or ▼)

--General Setup Page--

TV Display	Wide
Angle Mark	On
OSD Lang	Eng
SPDIF Output	
Captions	Off
Screen Saver	On

Go To General Setup Page



(Press ►, ▲ or ▼, then press ENTER)

--General Setup Page--

TV Display	Wide
Angle Mark	On
OSD Lang	Eng
SPDIF Output	
Captions	Off
Screen Saver	On

Closed Captions

Screen Saver

Example showing how to set Screen Saver on/off:

(Press ▲ or ▼)

--General Setup Page--

TV Display	Wide
Angle Mark	On
OSD Lang	Eng
SPDIF Output	
Captions	Off
Screen Saver	On

Go To General Setup Page



(Press ►, ▲ or ▼, then press ENTER)

--General Setup Page--

TV Display	Wide
Angle Mark	On
OSD Lang	Eng
SPDIF Output	
Captions	Off
Screen Saver	On

Screen Saver

--Audio Setup--**Dual Mono**

Example showing how to set stereo mode:

(Press ▲ or ▼)

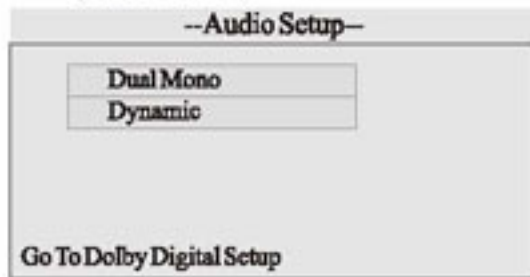

(Press ►, ▲ or ▼, then press ENTER)

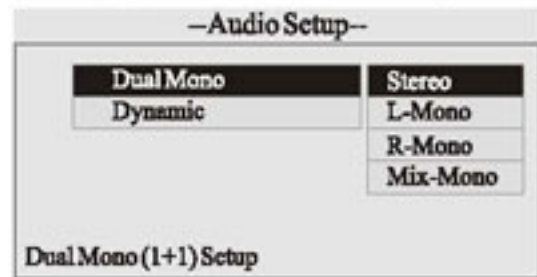
**Dynamic**

Example showing how to set dynamic range compression:

(Press ▲ or ▼)



(Press ►, ▲ or ▼, then press ENTER)

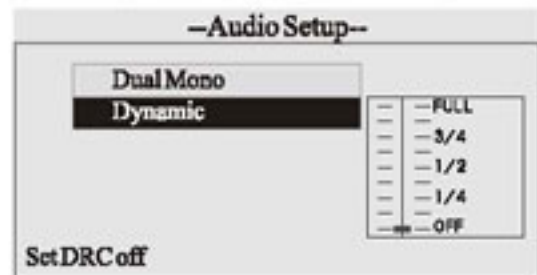

---Preference page---

TVType

Example showing how to set TV type:

(Press ▲ or ▼)

--Preference Page--

TVType	Auto
Audio	Eng
Subtitle	Eng
Disc Menu	Eng
Parental	
Password	
Default	

Go To Preference Page



(Press ►, ▲ or ▼, then press ENTER)

--Preference Page--

TVType	Auto	PAL
Audio	Eng	Auto
Subtitle	Eng	NTSC
Disc Menu	Eng	
Parental		
Password		
Default		

Set TV Standard

Audio

Example showing how to set Audio language:

(Press ▲ or ▼)

--Preference Page--

TVType	Auto
Audio	Eng
Subtitle	Eng
Disc Menu	Eng
Parental	
Password	
Default	

Go To Preference Page



(Press ►, ▲ or ▼, then press ENTER)

--Preference Page--

TVType	Auto	
Audio	Eng	English
Subtitle	Eng	
Disc Menu	Eng	
Parental		
Password		
Default		

Preferred Audio Language

Subtitle

Example showing how to set subtitle language:

(Press ▲ or ▼)

--Preference Page--

TVType	Auto
Audio	Eng
Subtitle	Eng
Disc Menu	Eng
Parental	
Password	
Default	

Go To Preference Page



(Press ►, ▲ or ▼, then press ENTER)

--Preference Page--

TVType	Auto	
Audio	Eng	
Subtitle	Eng	English
Disc Menu	Eng	Off
Parental		
Password		
Default		

Preferred subtitle Language

---Preferences page---

Disc Menu Example showing how to set Disc Menu Language:

(Press ▲ or ▼)

--Preference Page--	
TV Type	Auto
Audio	Eng
Subtitle	Eng
Disc Menu	Eng
Parental	
Password	
Default	

Go To Preference Page

➔

(Press ▶, ▲ or ▼, then press ENTER)

--Preference Page--		
TV Type	Auto	
Audio	Eng	
Subtitle	Eng	
Disc Menu	Eng	English
Parental		
Password		
Default		

Preferred Menu Language

Parental Example showing how to set parental control:

(Press ▲ or ▼)

--Preference Page--	
TV Type	Auto
Audio	Eng
Subtitle	Eng
Disc Menu	Eng
Parental	
Password	
Default	

Go To Preference Page

➔

(Press ▶, ▲ or ▼, then press ENTER)

--Preference Page--		
TV Type	Auto	2 G ▲
Audio	Eng	3 PG
Subtitle	Eng	4 PG 13
Disc Menu	Eng	5 PGR
Parental		6 R
Password		7 NC 17
Default		8 Adult
		Off

Set Parental Control

Password Example showing how to set password, and the default password is 8888.

(Press ▲ or ▼)

--Preference Page--	
TV Type	Auto
Audio	Eng
Subtitle	Eng
Disc Menu	Eng
Parental	
Password	
Default	

Go To Preference Page

➔

(Press ▶, ▲ or ▼, then press ENTER)

--Preference Page--		
TV Type	Auto	
Audio	Eng	
Subtitle	Eng	
Disc Menu	Eng	
Parental		
Password		Change
Default		

Change Password

---Preferences page--

Default Example showing how to set load factory setting:

(Press ▲ or ▼)

--Preference Page--

TV Type	Auto
Audio	Eng
Subtitle	Eng
Disc Mem	Eng
Parental	
Password	
Default	

Go To Preference Page

➔

(Press ▶, ▲ or ▼, then press ENTER)

--Preference Page--

TV Type	Auto
Audio	Eng
Subtitle	Eng
Disc Mem	Eng
Parental	
Password	
Default	Reset

Load Factory Setting

Basic Operation of Discs

Once you want to play VCD/CD/MP3, insert a disc into the slot, the unit will automatically switch on, if a disc is loaded, press **1** **MODE** to start the playback.

Note:

- * Pressing MOD button in the head unit also performs the same operation.
- * The disc can be inserted and ejected in AV mode.

Playing Track F.F/F.REW

Press **12** **▶▶** or **10** **◀◀** to play the track fast forward or fast rewind: each pressing, the change is as following:

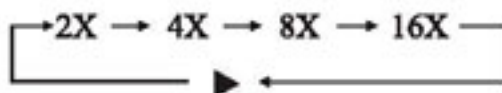

Note:

- * This function can only be operated by the remote control.

Number Buttons

press **14** **Number Buttons** to input the desired tracks, then it will be played automatically.

Note:

- * This function is operated by using the remote control.

Repeat Playing

During playback, press **9** **REPEAT** to activate the repeat function, press it again to cancel repeat playing.

Note:

- * This function is operated by using the remote control.
- * The default setting is **DISC REPEAT**.

Stop the playback

During playback, firstly pressing **4** **■** to pause playing, press **5** **▶▶** to play, press **■** button twice to stop playing completely, press **PLAY** button to start playing.

Note:

- * Pressing STOP in the head unit also performs the same function.

Pause the playback

During playback, press **5** **▶▶** to switch pause and play mode, during stop mode, press it again to resume to the playback mode.

Note:

- * Pressing PLAY in the head unit also performs the same function.

Playing the Previous/Next Track

During MP3 mode, briefly press **8** **◀** to play the previous track, briefly press **3** **▶** to play the next one.

During VCD/CD playback, briefly press **8** **◀** to replay the current track, briefly press it again within 3 seconds to play the previous track, briefly press **3** **▶** to play the next one.

Note:

- * Pressing PREV and NEXT button in the head unit also perform the same operation.

VCD/CD/MP3

System Button

During VCD playback, press **7** **SHIFT** till **[fS]** appears, then press **18** **P/N** button to select standard TV system: AUTO, NTSC, PAL.

Note:

- This function also can be operated by the DVD SETUP MENU

Slow motion playback

During VCD playback, press **7** **SHIFT** till **[fS]** appears, press **3** **SLOW** to slow forward or slow backward. There are such speeds each pressing decreases the speed until the minimum speed is reached as follows:



Note:

- This function is operated by using the remote control.

Increase the size of the picture

During VCD playback, press **7** **SHIFT** till **[fS]** appears, press **8** **ZOOM** to increase the picture in size. There are such sizes as following:

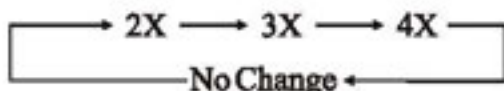

Note:

- This function is operated by using the remote control.
- Pressing **[<] [▶] [▲] [▼]** to remove the picture.

On-screen display

During VCD/CD mode, press **11** **DISPLAY**, the monitor shows:

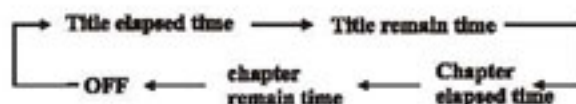

Note:

- This function is operated by using the remote control.

MO/ST Selector

During VCD playing, repeatedly press **18** **L/R** button to select the mode as bellow:

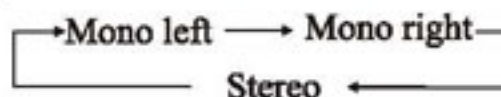

Note:

- This function is operated by using the remote control.

MP3 Selector

During MP3 stop mode, press **[<] [▶] [▲] [▼]** to select documents or files, press ENTER to enter what you chosen.

Note:

- This function is operated by using the remote control.

Playing PBC (Menu)

During VCD status, firstly pressing **17** **TITLE**, PBC playback starts and the menu of entire disc appears in the monitor. And then you can select your favorite track by using Number Buttons **14**. When a track is playing, you can press **16** **MENU** button to return the menu if you would like to end the track and select others. To cancel PBC playing, press **17** **TITLE** button again.

Note:

- This function is operated by using the remote control.
- PBC playing confirms to version 2.0 of SVCD/VCD disc only.

Turn the Unit On/Off

Press **1 PWR** button to turn on the unit, press it again lastingly to enter the waiting status.

Note:

- Pressing PWR in the head unit performs the same function.

MO/ST Selector

During playback mode, briefly press **1 MODE** to switch to TV mode, briefly press it again to return to the playback.

Note:

- Briefly pressing MOD in the head unit performs the same function. During AV mode, briefly press MOD to switch to TV mode.

TV Mode

During TV mode, press **1 OSD** to display the current status and volume range.

Note:

- Pressing OSD in the head unit performs the same function.

Mute Function

During TV mode, press **4 MUTE** to cut down the volume output, press it again to resume to previous status.

Note:

- Pressing MUT in the head unit performs the same function.

System Selector

During TV status, press **15 P/N** button to select standard TV system as following:

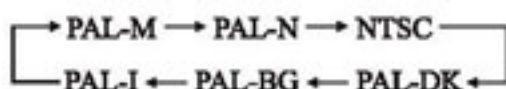

Note:

- This function is operated by using the remote control only.

Stations Selector

Stations Selector: During TV mode, press **9 -/--**, the monitor shows " ", you can select less than 10 stations by pressing **14 Number Buttons**, press this button again to shows "--", you can select the stations among 10 to 99 by pressing **14**.

Note:

- This function is operated by using the remote control only.
- Only less than 99 stations can be selected by this function.

Searching Stations Automatically:

During TV mode, press **5 AUTO**, the monitor shows "SEARCH...", press **6 CH+** to start searching, press **6 CH-** to stop searching.

Note:

- This function also can be operated by pressing AUTO and CH+/CH- in the head unit.

Skipping backward/forward to select channel:

under TV mode, press **6 CH+** to skip backward to select channel from the current one; press **6 CH-** to skip forward to select channel from the current one. if you select channel forward from the last one, the system will start from "0"; or if you select backward form "0", it will skip to the end, select channel backward.

Note:

- This function also can be operated by pressing CH+/CH- in the head unit.

Additional Information

Simple Troubleshooting Guide

The following checklist might help to solve the problems which you meet when using the unit. Please double check and make sure if the connection and the procedure of the operation is properly before using the checklist below .

Problem	Cause/Solution
No power.	<ul style="list-style-type: none"> • Check and make sure whether the fuse is blown, replace with the proper value if necessary.
Some errors occur in the LCD or no function when pressing the button.	<ul style="list-style-type: none"> • Press RESET button.
Unable to receive stations.	<ul style="list-style-type: none"> • Check and make sure whether the antenna is inserted or the antenna is properly connected, if not, insert the antenna or connect it properly.
Poor effect on receiving a station.	<ul style="list-style-type: none"> • Antenna may not be the proper length. Make sure the antenna is fully extended; if broken, replace the antenna with a new one. • The antenna is poorly grounded, check and make sure the antenna is properly grounded at its mounting location. .
CDs cannot be loaded.	<ul style="list-style-type: none"> • A CD is loaded in the mechanism.
Sound skips.	<ul style="list-style-type: none"> • The CD is dirty or damaged.
No images.	<ul style="list-style-type: none"> • The Video line from main unit to the TV is not connected properly.
Images skip.	<ul style="list-style-type: none"> • Improper setting of the color system. Set the color system to "PAL" or "NTSC" according to the connected television.

Note:

If any of the problem persist after check list had been made, consult your nearest service dealer. Never attempt to disassemble your unit by yourself.



Due to continuous product improvement, the operations are subject to run the model.